

come.
come closer.
find
**where you
want to be.**

acristalia
adifferentcatalog.

where you want to be



**...concept, design,
differentiation,
logistical advantage,
professionals,
response, security.**

**We are all of this
and more.**

**We have come
a long way.**



07

demand quality, choose Acristalia.

why
Acristalia?



/ background

- this is who we are p. 9
- defining the space p. 10
- complying with the rules p. 12

17

glass walls

versatile, functional
and with endless possibilities



/ in common

- get to know our glass walls p. 19
- general features p. 20

/ systems

- sliding folding systems p. 21
- standard and basic pro series
- sliding system without p. 29
- bottom profile
- star series
- panoramic slider p. 35
- tandem series

43

sliding glass roofs

indoors but outdoors,
is achievable.



/ in common

- get to know our p. 45
- sliding roofs
- a customized configuration p. 47
- to your needs

/ features

- a cutting-edge p. 48
- generation
- minimalista and panoramic series

55

fixed roofs

advanced design,
resistant and durable.



/ in common

- get to know our p. 57
- fixed roofs

/ features

- which option suits p. 59
- you best?
- atlas series and atlas
- self-supporting series

63

bioclimatic pergola

create an oasis in your garden
and enjoy it all year round.



/ introduction

- get to know our pergola p. 64
- the Pergola series by Acristalia

/ features

- technical features p. 69

75

vertical sliding glass wall

a panoramic
multifunctional system.



/ introduction and features

- get to know our guillotine p. 76
- brisa series

83

glass windbreaker

a step further in the
space enclosure.



/ introduction

get to know our wind-
breaker
ascendo and fixendo series

p. 84

/ features

installation possibilities

p. 86

89

glass railings

a clear
vision.



/ introduction

get to know our railing
railing series

p. 90

discover other options
romo, vorte and conect series

p. 93

97

possible combinations

renovate
your space.



/ projects

combine our series

p. 98



where you want to be





demand quality, choose acristalia

We consider ourselves as creators of moments, experiences, dreams... and we reflect this in all the products we develop. **We give a second chance to forgotten spaces, to places that we only enjoy in certain seasons... so we can fill them with new life.**

In this section, we encourage you to take a look and learn more about us and the team that shapes Acristalia and makes each of the projects presented to us a reality.

We design, manufacture, commercialise, distribute, and, of course, we provide technical assistance. From its very beginning, Acristalia has made a difference and provides an indisputable logistical advantage.

Our departments are composed of qualified professionals in each field. Among them we would like to highlight the **R&D&I section, made up of engineers who always manage to find improvements, updates to our products and the incorporation of new systems,** which make our catalog of solutions grow to fulfil the needs of our clients.

In addition, the **Technical Department,** together with the **Customer Service Department,** will be at your service before, during and after installation.

where you want to be

catalog





this is who we are

demand quality, **choose Acristalia**
why Acristalia?

“

In a market as competitive as that of glass enclosures, it is always necessary to go further.

Acristalia has a **network of specialized and qualified professionals to offer the best service**. This vast network continues to grow, expanding beyond our borders. More and more people trust the Acristalia brand and our way of doing things, a business model that is solid and experienced. **We reach where the end user is.**

+

Own manufacturing and punctuality
in delivery times

Exhaustive **quality controls**

Technical and commercial **support**

Individualized access and after-sales support

By installing our products where glass is the protagonist, our clients discover a panoramic view that transports them to a new world of sensations, where they can enjoy the environment in which they find themselves, entering into the landscape without leaving the comfort of their home or their regular premises.

As a result, are created new places to remember, new homes to return to, shelters to come back to feel accompanied or enjoy a moment of solitude. They thus become places where we want to be.

“

If we want to raise our culture to a higher level, we are forced, for better or worse, to transform our architecture. And we will only achieve this if we leave the spaces in which we live free of anything closed, which requires the introduction of glass architecture.

Bruno Taut



defining the space

demand quality. choose Acristalia
Why Acristalia?



complying with the rules

Acristalia manufactures all its products under **strict quality controls** regulated and specified in the quality management system **in accordance with standard UNE-EN ISO 9001:2015**, and guarantees that all materials used in the manufacture of its products are of the highest quality, complying with the following regulations: **Aluminium with CE marking** in accordance with the new European regulation on construction products (EU) 305/2011 and the harmonised standard UNEEN 15088:2006 (aluminium and aluminium alloy products for structural applications).

Guarantee on **aluminium profile materials** in terms of material purity and possible corrosion caused by impurities or factory incrustations according to EN 15088:2006, EN 755-9:2016.

Anti-deformation guarantee of the aluminum, either their own or due to a lack or shortage of tempering in the profiles.

Guarantee on **finishes, lacquers and anodizing** as stipulated by the European quality mark Qualicoat, Qualanod, Qualideco, approved by the Ministry of Public Works for surface treatments with powder. These treatments guarantee uniform ageing of colours with no patches or occasional discolouration.

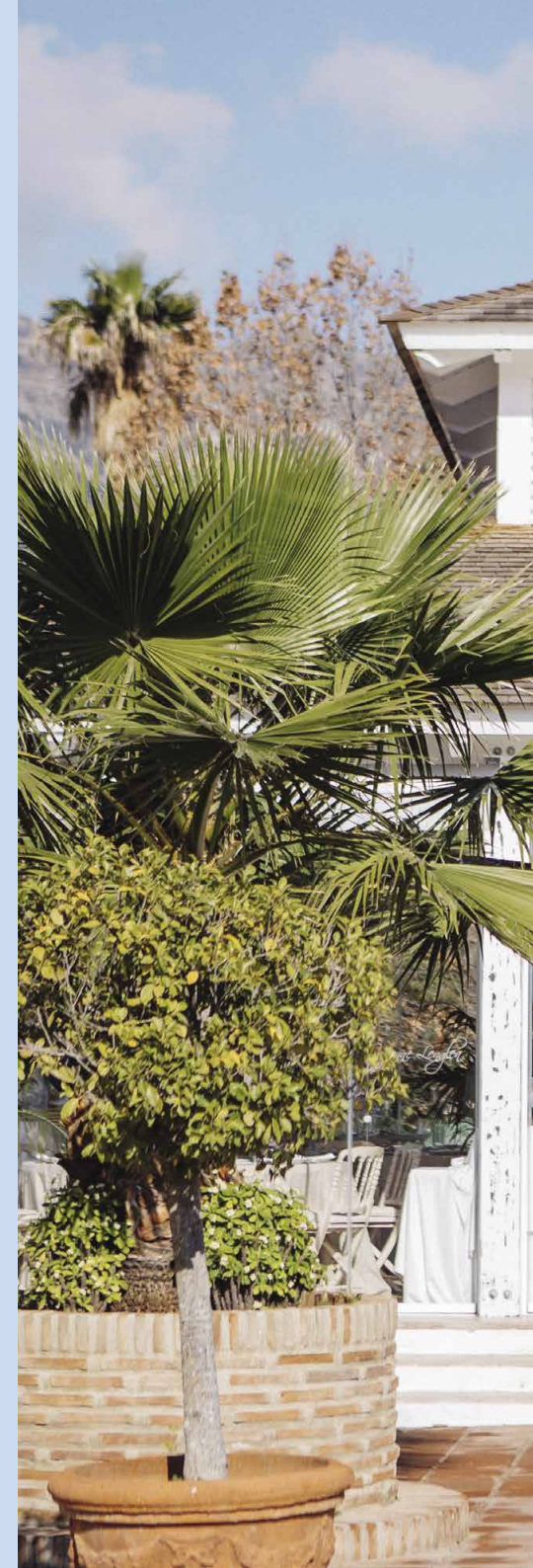



“

**Your project? In
the best hands and
with the quality
you deserve.**

**Expert advice
and certified
products products:
an authentic
Acristalia
experience.**

+

Certifications

Our products are subjected to strict controls, tests, and trials. **We work to ensure that Acristalia's products are synonymous with safety and reliability.**

For further information on these trials, please visit the 'Documentation' section at acristalia.com. **We do inform you... knowing is winning!**



and now...

we begin!

where you want to be

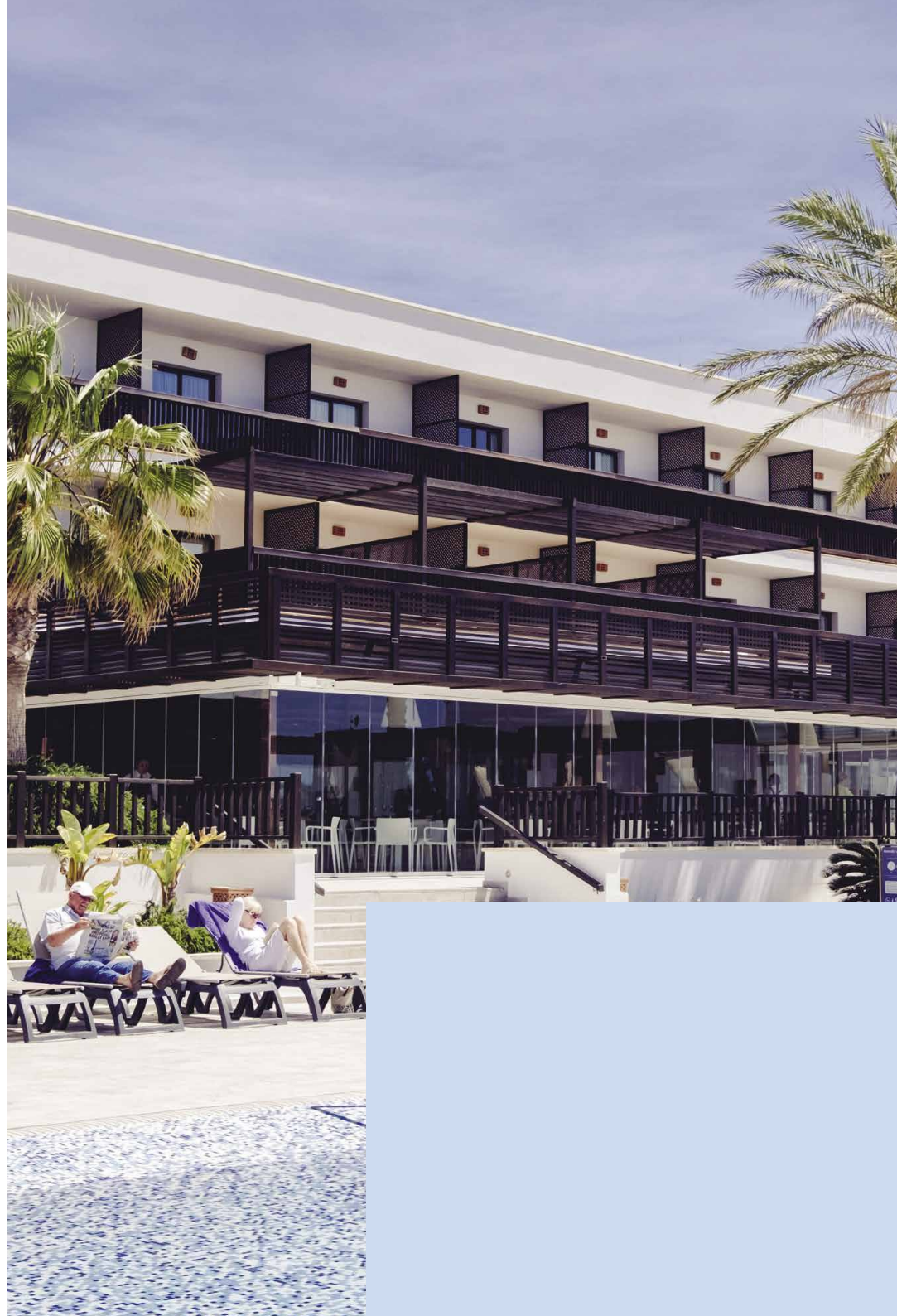

glass walls

glass walls
infinite possibilities

The glass walls are an excellent architectural solution, **which is extremely installation possibilities.** They feature flexible openings and closings, **allowing them to be fully or partially integrated** with the exterior by means of sliding and storage areas. **They adapt to different spaces** such as balconies, terraces, porches, attics and even as **interior partitions, where luminosity and views are preserved.**

With a minimalist **design and customization in size**, shape and finishes allow them to integrate harmoniously with any architectural style.

In addition, they **improve comfort** thanks to acoustic insulation and reduced need for air conditioning.

To summarize, the glass walls are easy to maintain, highly durable **and adapt to multiple needs and styles, offering functionality, aesthetics and durability in both exterior and interior installations.**



play video!

where you want to be



discover our glass walls



The Frameless Slide&Turn Standard series represents an **evolution** of the concept of the glazed enclosure in the quest for versatility. In the following pages we will review the main features that make the Standard Series a benchmark in the glazing world. This document is intended to show **the advantages and technical features** of the product.

This dossier presents the results of **the trials carried out** on the glass system, a guide detailing the installation possibilities, as well as the technical features concerning the glass sizes and types of aluminium profiles used. A comprehensive overview of information that accompanies **the careful design and functionality** of this article.



The system has a wide range of possibilities in terms of **finishes and colour combinations** of the profiles, adapting to any preference or corporate image.



Perfect solution for integration in both **facades and interiors**, being suitable for both **refurbishment and new construction** projects.



Such **adaptability and implementation** is enhanced with the possibility of **printing the glass** sheets in the factory, thanks to our digital **vitrified printing system**.



Sliding glass panels without vertical profiles provide **seamless and transparent surfaces** with all the functional components concealed.

general features

Structural reliability

The top and bottom panel profiles ensure a **consistent stability**. The glazing has **mechanical fixation in the upper panel profile** to prevent the glass from detaching from the profile.

Minimal visual impact

Functional components are discreetly hidden inside the profile. The system has no vertical profiles between the panels, **guaranteeing a uniform glass surface** throughout the opening without visual impediments.

Easy adjustment

Transparent vertical sealing strips that are easy to fit after installation of the system and can be just as easily removed to accommodate the room temperature or for optimal cleaning.

Insulation

Double sealing laminated mat both at the top and bottom guide where they meet with the respective panel profiles to **minimise air and water flow**. The tongue and groove caps seal the joints between the panel profiles.

Bespoke design

Extremely versatile system where any panel can be converted into an opening, creating a **new parking area** to collect the sliding leaves.

Smooth sliding

The Standard series panels carry their weight on the top guide, guaranteeing an **easy and smooth sliding of its panels along the upper guide**.



sliding folding systems

The Standard series versatility is proven by the **wide range of installation possibilities**. They are **extremely adaptable** to any type of frame.

For example, this series is able to adapt to almost any type of layout, **like L-shaped or any other polygonal shape**.

ristalia

glass walls **Standard** and **Basic Pro** Series



where you want to be

_ Installation options



The opening direction of the panels is adjustable. Either interior or exterior opening is allowed, depending on the requirements of the project.

The Standard Series features the option of a recessed bottom guide to facilitate accessibility to the space and eliminating any architectural barrier.

Regardless of the type of structure and project, every sliding panel moves horizontally smoothly and lightly.

The Standard Series features an integrated magnetic system to keep panels together and a discreet and easy-to-use snap-lock with a ratchet clip to secure door.

The projected layout of the system could be arranged in sections with different configurations.

In the following examples we can see different settings in the same installation, such as the "polygonal" which shows the adaptability of the Standard series.

Despite the difficulties we face, we achieve equally functional sections within the same system, providing visual consistency to the space as a whole.





As shown in the pictures below, it must be taken into account that in installations **with panels sliding along an angle** a minimum space that is invaded must be respected.

For installations with angles, please consult with **our sales department to develop the ideal solution.**



The Basic Pro Series and the Railing Series railing by Acristalia can be combined and mounted together, fitting each other like a glove.

The railing system is designed to achieve full compatibility between the Basic Pro and Railing Series using the last one's handrail as the **bottom profile of this Slide & Turn system.** By combining this solution we will have a place that is completely safe, yet full of light and comfort.



play video

where you want to be



BRASERIA

11 sunset
11 sunset



Each detail,
every fea-
ture of our
system... **we**
do tell you
about it!

_ Panels. Easy and tidy

The Standard Series can reach a **panel height of up to 3 metres and a width of 80 cm**, making it very versatile in terms of the adaptability possibilities to be installed as required by the project.

With regard to the **types of glass** employed, this series allows for the installation of **tempered or laminated glass**. With the option of **translucent, opaque and solar control glass**. **Thicknesses of 6, 8, 10 and 12 mm**.

Thanks to its **leveling profile**, any unevenness of the structures can be corrected without any difficulties.



The ratio of the glass thickness and the maximum height of the panels is **directly proportional**. In other words, **the larger the height, the thicker the required glass thickness**.



Maximum weights.
Maximum weight of **each panel 55 Kg**.
Maximum weight of **the opening 70 Kg**.

Cable de **acero inoxidable** que conecta los pestillos superior e inferior al tirar de él.

_ Integrated solutions

These are the **main technical features** of the system design to suit **the needs of our customers**. Below, we show the most outstanding accessories that integrate the system.

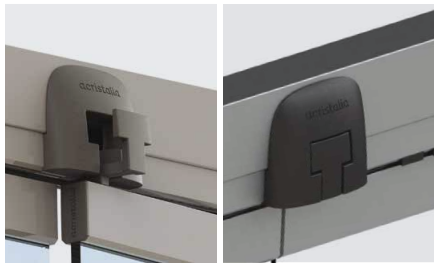

Upper wheel outlet

The outlet system is **fully integrated** into the system **avoiding being an obstacle for blinds, shutters, and textile curtains**.

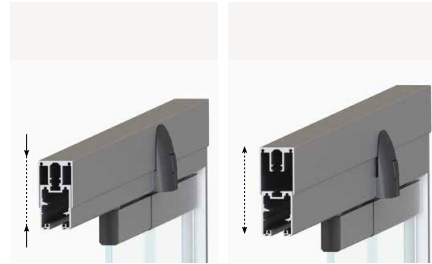

Levelling profile (recommended)

The levelling profile (optional but recommended) allows to adjust the height of the area **up to 25 mm**.



Tongue and groove caps

By means of the design of the tongue-and-groove caps, we achieved a sturdiness that **improves the resistance to both water and air**.

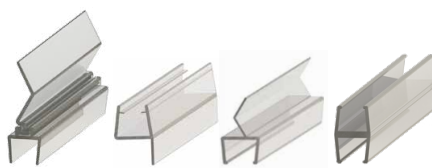

Sealing strips

The high quality of the materials along with a production process that uses the most advanced technologies results in a **very reliable product** with unbeatable characteristics.

_ Locking mechanisms

The type of locking system will be determined by **the required level of security and direction of the opening panels**. Our technical and sales departments will advise you about the most suitable option for your project.



Lock with cable

Stainless steel connection between the upper and lower latches when pulled.



Security lock with handle

We offer a choice of **wired or wireless** locking mechanisms, both **equipped with latches** for key operation of the main leaf. For enhanced security, the wired system engages a **three-point locking** mechanism, providing superior protection for your enclosure. The system is designed for convenient access **from either side**.



Turn knob

Allows to operate **the steel cable operating** the latches while at the same time helps us to direct the panel to its parking place. **It is possible to use the knob from the inside, the outside or both at the same time**.



Sliding lock/Lower latch lock

Provides resistance to strong winds and adverse weather conditions. **It has been tested with results that ensure its resistance to winds of more than 190 km/h**. The lower latch lock **enables you to lock** opening of the system by using a key and a lock. Also valid for cases of protection against external threats or as **security to prevent children from operating the system**.

_ Add-ons and accessories

Pleated curtains are an ingenious and simple solution, designed to fit perfectly adapted to our glass walls.

The highlight of this accessory is its ability to **occupy minimal space** when folded up, thus achieving its **simple and elegant design**, a subtle touch of design in any environment, with a palette of colors fully combinable with the decoration of the space chosen for its placement.



“
**Textures, colors,
control of the light
entrance... check
out the options
the pleated
curtains.**”



The sizes of the pleated curtains are **directly related linked to the size of the sheet of the glass panels** where they will be installed, although, in certain special cases, it will be necessary to take into account, some aspects



Up to **3 meters high**
Max. 80 cm panel width
Adhesive profile for glass from 6 to 12 mm
Clamp strip for glass from 6 to 10 mm



sliding folding system without bottom profile

The Star sliding and turn glass panel system is a flexible solution that can be adapted to a wide range of customer specifications, **whether in straight, angled or straight, angled or curved configurations.**

The main virtue of the system is that it does **not require guides on the floor**, making it possible to create a **complete enclosure without obstacles while passing through**, as well as the possibility of incorporating opening glasses at any intermediate point of the system with an optional door closer.

This system is available in the following **glass thicknesses:** 10 mm and 12 mm by default, and thicknesses of 12.8 mm, 13.5 mm, 15 mm, 17 mm and 19 mm upon request.

The pressing and gluing system guarantees **fixing without drilling holes** in the glass, making it compatible with the use of laminated, although from Acristalia we always advise the use of the use of **tempered or tempered laminated glass** due to its greater resistance to impact and thermal stress.

frameless glazing Star Series

_ Highlights of the system

The possibility of **embedding the upper guide in a false ceiling, as well as the absence of a lower guide**, make the Star Series a practical system in terms of cleaning, as well as functional thanks to the lack of obstacles and minimalist aesthetics, making it easy to integrate into any context.

As it has no bottom guide, it can also be adapted to steep slopes on the ground, provided that the panels move from the side with the lowest height to the side with the maximum height.



Each of the sliding panels can be configured as an entrance door, **resulting in a very versatile system.** This opening will have a **locking system that allows to alternate the panel between its opening function and the sliding function**, allowing both to collect the panel in the parking space and to use it as an opening when the system is closed. This panel locking system has a color display so that, at a glance, we know the position in which the latch is located.

Standard parking layout

With pivoting end panel as possible access (left and/or right).

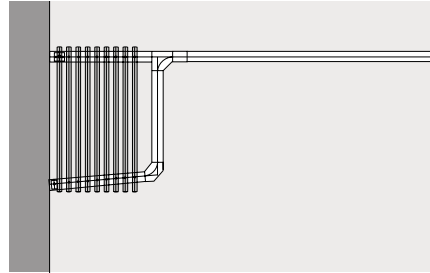

Parking with guide at 135° behind a column

With pivoting final panel as possible access (left and/or right).

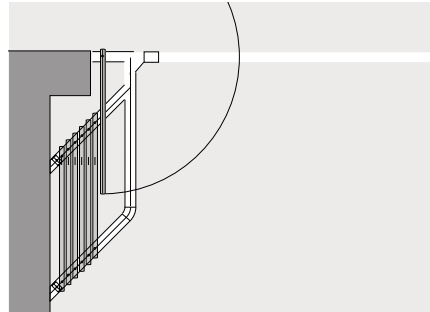

Parking at 95°

For a small number of panels (up to 6), left and/or right.

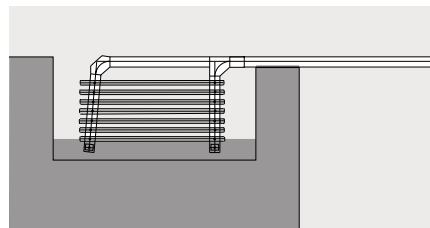

_ Parking area

The STAR systems can store the panels in different positions:

_ Panels can be aligned parallel or perpendicular to the glass front.

_ They can be stored visibly or hidden in niches, behind columns, etc.

_ The system can be stacked in line or out of line, either behind a wall or inside a gap.

_ The panels can perform certain functions when the front is open, such as acting as the sides of shop windows or adding artistic value thanks to the possibilities of digital printing, etc.

The following are some of the most representative options (contact us for more information):





In terms of **opening systems**, the STAR system has the following **options for both fixed and intermediate openings**: security lock with knob, single or double handle with floor lock and 'H' handle plus floor lock.

where you want to be



_ Installation possibilities

Existing structures or unusual designs often require special solutions, particularly in **the choice of panel type and in the design of the parking area.**

_ All panels are supplied with their top and bottom panels profile perfectly fixed to the glass.

_ While sliding panels and fixed openings can be installed without a spacer profile, **it is required for intermediate opening panels.**

It is recommended that where such intermediate openings are provided, the spacer profile should be added to the rest of the panels to improve the aesthetic appearance (giving visual integration to the enclosure) as well as better strip contact to improve watertightness.

_ This system is available with the following glass thicknesses: **10 mm and 12 mm as default, and thicknesses of 12.8 mm, 13.5 mm, 15 mm, 17 mm and 19 mm on request.**

_ The pressure and gluing system guarantees fixing without the need to drill holes in the glass, making it possible to use laminated glass, although **Acristalia always advises the use of tempered or tempered-laminated glass due to its higher resistance to impact and thermal stress.**

_ The top panel profile incorporates the double brush as standard. **Optionally, it is possible to request a double brush in the bottom profile.**

“

The constraints of the project are nothing more than challenges for us, and we are more than prepared to overcome them.

where you want to be



panoramic sliding glass door

The Tandem Series is a solution for those projects that require **the economy of space** by ensuring that the system does not invade the adjoining area and in those installations that need the weight of the system to rest on the lower guide.

This is why it is considered the flagship product within the restaurant sector.

This document is intended to serve as a tool to learn more about **the technical and visual features of the most panoramic system in our catalog.**

sliding glass door **tandem** series

_ Some features

The panels

Panoramic sliding doors can reach a maximum **height of 3.5 metres, with superpanoramic panels of up to 2 metres wide** depending on their weight (max. 100 kg). These can be made of tempered, laminated or solar control glass. Basically, any composition with a total thickness of 10 or 12 mm.

Practical and functional guide design

The Tandem Series has two options for its guides: **continuous and optimized**. In addition, you can opt for the **in-floor rails to further facilitate the passage of obstacles**.

The optimized rails are designed to **facilitate water drainage and cleaning of the rails**.

In the case of continuous guides, they have the advantage of two-way opening.

_ Guide options

Our **stainless steel guides are the main differentiating element of our panoramic sliding system** with respect to the rest of the market. Below, we show the different options of guides that the system allows. Both of them have their benefits, both aesthetic and useful, so it **will depend on the needs of each project whether to choose one or the other**.



Continuous rails

The continuous rails have INOX guides along the entire length of the guide, which allows the **double opening direction**. These rails have the option of **machining the outlets for the correct water drainage**.



Optimised rails

The optimised rails have trimmed guides that **only allow opening in one direction**, leaving one panel always fixed. As an advantage, **it is easier to evacuate water** (no drains are required), the lower guide is **easier to clean** and the visual appearance of the product is enhanced.

_ Opening mechanisms

With regard to the opening mechanisms, the panoramic sliding door has the following alternatives: **security lock with central opening or side opening, security lock with 90° opening or flush finger pull**. The last one can be completed with a push lock to lock the panel. This will be installed in the side frame.



“
The Tandem Series panoramic slider is one of our star products.”

where you want to be

on your terrace, in your garden, in your business... **and always the option that best suits you!**

The Acristalia panoramic sliding doors offer different types of configuration different **types of installation** to suit the requirements of any project. As shown in the following images it is possible **to install from 1 to 10 panels per partition**. **The opening can be either side or central**. In addition, **it is possible to open at an angle for corner installations**.

The installation should be arranged in such a way that simply moving the main panel(s) allows the entire system to be opened or closed.

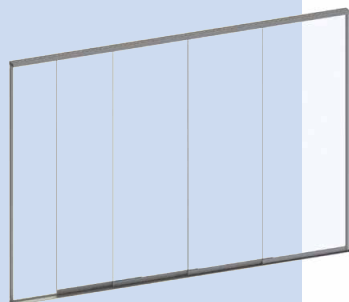

Side opening

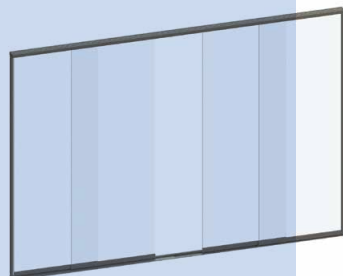

Central opening

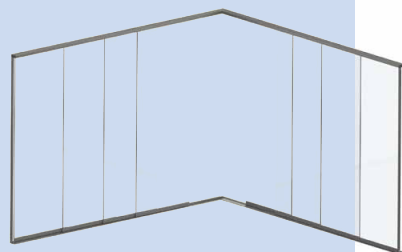

Angled opening



_ Further outstanding features

This section describes the range of technical features of the **system making it an all-in-one system as it is practical, functional, and visually appealing.**

Anti-theft device

These parts **prevent the panel from being lifted up**, therefore preventing malicious manipulation.

This security add-on currently comes as standard. However, we have developed it so that it can be fixed on an already installed Tandem. See our document *Retrofitting of the anti-theft system.*



Top guide trim covers

For the optimized rail option, the top guide is fitted with a **trim cover to improve the look of the design** in the unused part of the rails.



For improved tightness

Our sealing strips with brush are barely visible and contributor to maintaining the panoramic concept. They come as standard. The plastic option is available on request.



To improve the tightness of the system, **a brush has been integrated inside the side frames and panel profile.**



before we continu

Our sliding roof incorporates cutting-edge motors **somfy**, capable of moving the Sliding Series panels without any difficulty. Its movement is driven by a small remote control.

e... did you know?

The motorization is completely integrated into the system, preserving the aesthetics of the product.

where you want to be

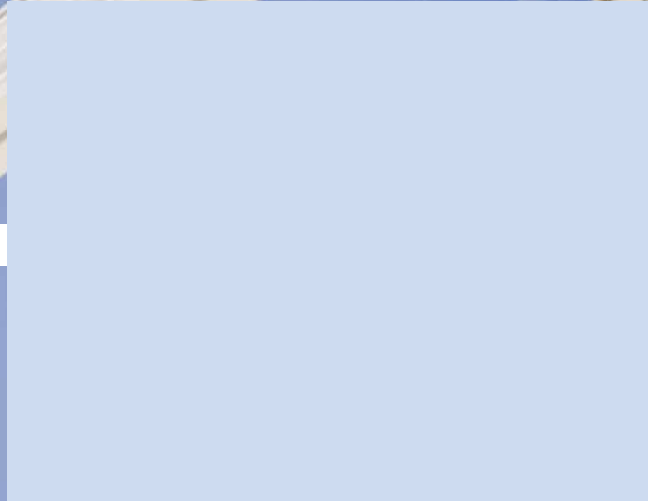
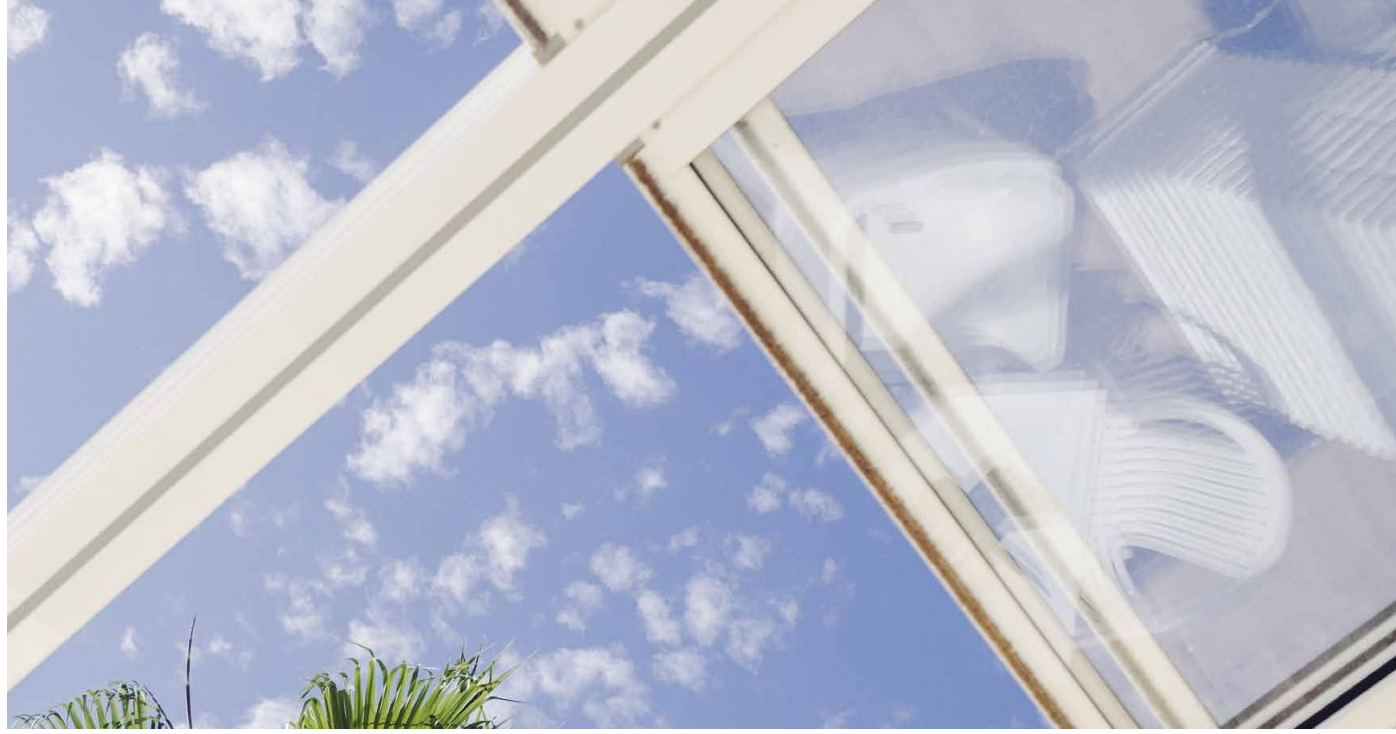

sliding glass roof

Now it is possible to enjoy a beautiful starry night under a roof. The transparency and the access to natural light allowed by the Acristalia Sliding series is a step further in the glazed enclosure industry. _It completes and gives meaning to the **panoramic view** of a home or business.

Flexibility, comfort and the possibility of creating a new space with a different atmosphere, without building work and with profiles with finishes that have a minimum visual impact.

Our roofs are also designed to provide **safety both during the installation and throughout its subsequent use.**



where you want to be



discover our sliding roofs

Our roofs are designed to be **the perfect solution for both homes and businesses**. An increasing number of hospitality professionals are recognizing the benefits of this product to continue to offer a comfortable space regardless of the time of year or season. This is also the case in those homes where they want to continue using the attic or terrace throughout the year. **It proves to be a convenient and practical solution.**

Thanks to the versatility of the materials used, **this product allows a wide variety of finishes for its profiles**: any color from the RAL chart, anodized, and imitation wood finishes. The roof panels can be made of sandwich sheet or glass, with different thicknesses and types: laminated, double glazing or any configuration up to 22 mm thick.



Motorized system of the **sliding glass panels that allows the enjoyment of the outdoor space all year round**, enabling the adjustment of the temperature of the space by natural ventilation.



Water drainage, whether during rain or cleaning, is carried out through the gutter and the support pillars. **The motorization is fully integrated and concealed within the system, remaining protected.**



You can enhance the system by adding any of our series of glass walls for the perimeter enclosure **and even manual awnings, veranda or vertical ones for solar control.**



The RAL colour chart allows you to customise the roof. In addition to the sized and the glass, the finishes and colours combine to suit all the tastes and needs of the home or business.



It offers the possibility of adding accessories such as lightning and automatic sensors that **can be controlled by WIFI systems.**



Delivery is pre-assembled and machined, **installation is very easy, quick and does not require any building work.** The installation is carried out completely from the inside

_ Advantages of our sliding roof

Sun protection

Thanks to the wide variety of solar control glasses, **the direct entry of solar radiation** is under control at any time of the day.

Furthermore, in our commitment to well-being and the search for comfort, the Sliding Series has **multiple verandas, canopies or vertical awnings** compatible and integrated with the structure of the retractable roof.

Ventilation

The motorization of the glass panels allows the creation of an air flow favored by the convection effect, from bottom to top, which regulates the temperature naturally.

Rain protection

Thanks to our design, water slides without retention across the surface towards an ejection gutter.



Our systems are prepared to face diverse environmental and meteorological situations. **Thanks to the sealing strips and mats we ensure the sealing of the perimeter and between the panels of the system**, ensuring the protection of the users under this umbrella.



The panels integrate sealing systems that **improve the permeability of the roof**, evacuating the passage of water at the junction between the sliding panels.

At the same time, **it prevents wind and reduces external noise** with the right combination of glass.



The **combination of a sliding roof with any of our sliding glass walls, increase comfort and safety** both at homes and businesses that want to create a new and unique space for the enjoyment leisure time.

a customized configuration

The Sliding Series brings together numerous possibilities in terms of design and distribution. The opening of the roof will vary depending on its dimensions.

The larger is the number of panels, the larger will be the opening capacity, varying from 50% in the S2 to 80% in the S5, approximately.

In addition, it can be adapted to the needs of each project. In such cases, alternatives such as the waterfall roof are available when the project requires the installation of a roof with a depth of more than 7 metres. We also provide gable roofs and solutions to uneven ones.

The system profiles are designed to allow both glass panels and sandwich panels.

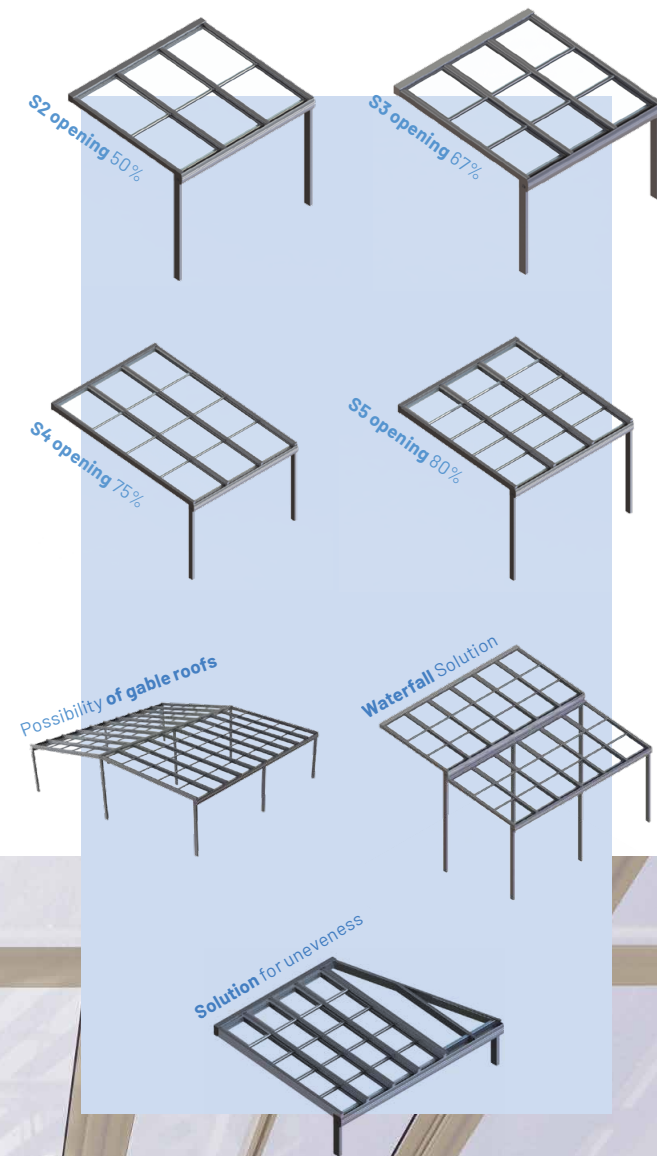

_ A cutting-edge system

Our sliding glass roofs have a robust and easy to assemble structure, in which all connections and fittings are hidden, **obtaining a clean and exclusive finish that differentiates us from the rest.**

Double transmission

Our roofs are equipped with a **double belt transmission system that drives both sides of the panels** in up and down direction. This system **generates a smooth movement and integrates panels with dimensions that reduce the number of lanes in the project.** This results in a better sensation of openness to the exterior.

Upper stoppers

The upper stoppers **guarantee a progressive closing of the panels,** achieving a smooth opening and closing control.

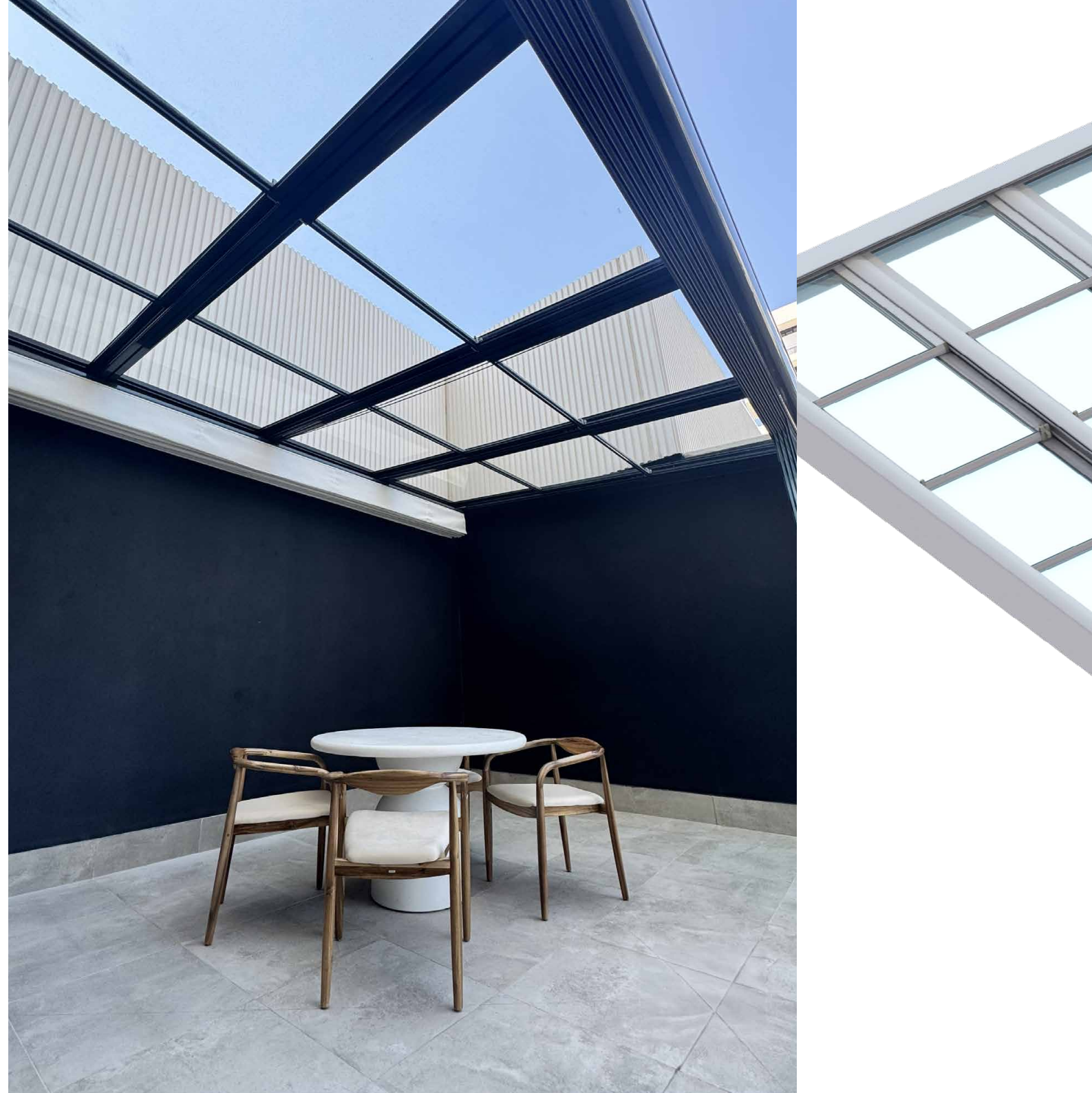



_ What are the highlights of the **Minimalist Series sliding roof**?

The Minimalist Series **stands out for its minimal horizontal profiles**, removing visual obstacles and creating a space that is even more open to the exterior. In addition, **it increases resistance to air and water tightness.**

“

A minimalist 100% flexible and combinable according to the practical and aesthetic requirements of the project.



_ Specifications of the **Panoramic Series** roof panel

Each one of our products has a unique quality that makes them relevant within our systems catalog, **being part of another alternative when designing a project.**

The main advantage of the Panoramic Series is that the panels **do not have horizontal profiles**, creating a more spacious view, a larger entrance of light into the room and the sensation, more than ever, **of being inside but in the open air.**



Other **important features:**

Panels without profiling at intersections, resulting in a panoramic view free of obstructions.

Transparent sealing strips between panels.

Allows 4+4 and 5+5 safety glass.

the double belt drive allows for wider panels increasing the panoramic view!



Double belt drive

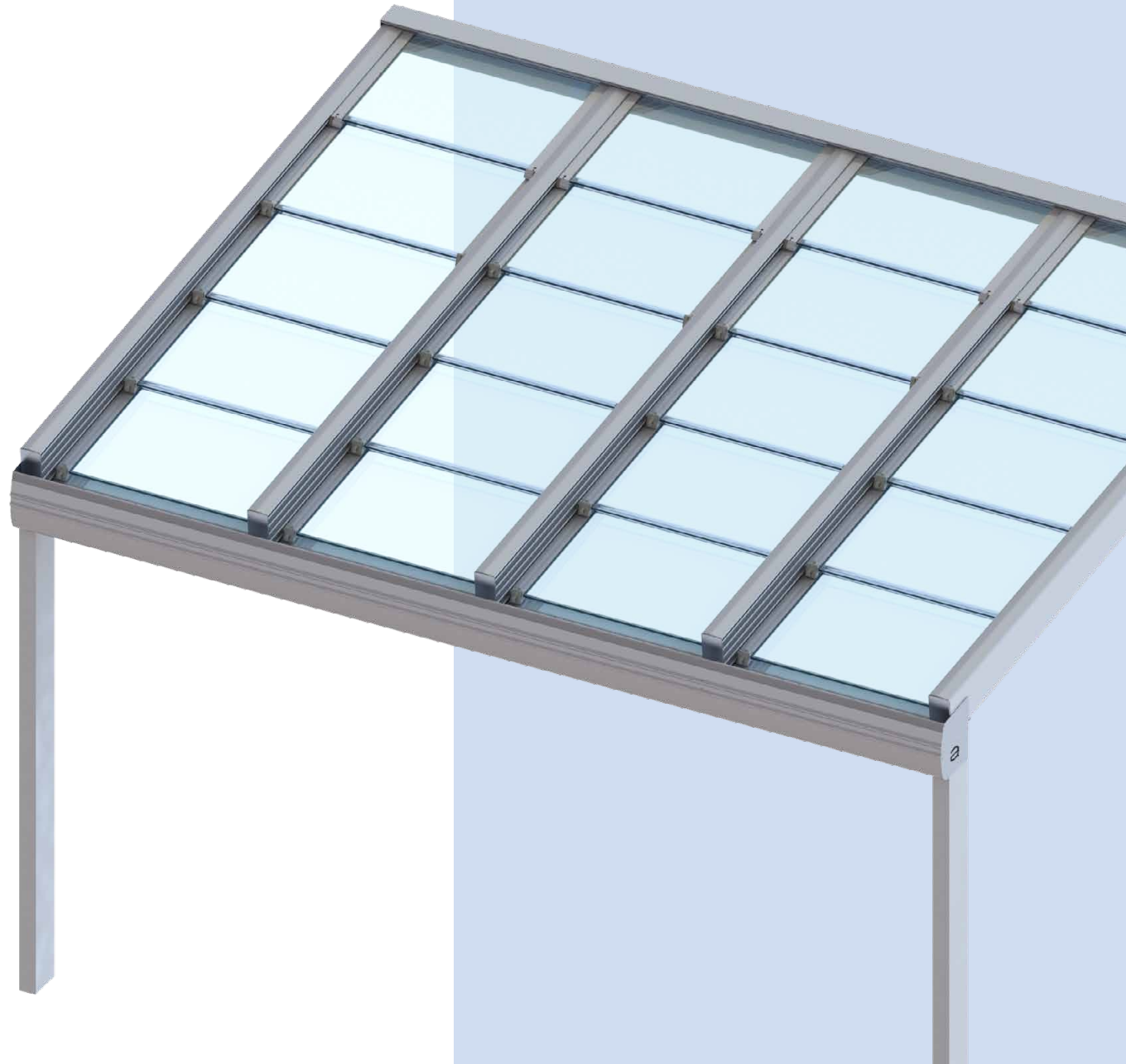

“

The system can be installed entirely from the inside, guaranteeing a simple and safe installation.

where you want to be

+

In our sector, to remain competitive you have to differentiate from the rest. At Acristalia, we have achieved that the sliding roof is compatible with two target sectors: the private and the professional.





_ Add-ons and accessories that make your life more comfortable

There are various accessories that we can incorporate into the structure of the mobile roof. Below the main additions that favor **the creation of a comfortable and welcoming environment** are defined and explained.



Sensors. They are safety elements that protect the structure, fixings and interior from strong winds and rain. They allow the automatic closing of mobile panels to improve well-being and at the same time **optimize energy performance.** The meteorological sensors manage the movement of the panels with total autonomy, according to the climatic and environmental conditions detected.



Home automation. In addition to the remote control already included, our Sliding roof can be equipped with **the TA-HOMA on request to be controlled via an app for smartphones and tablets through wifi connection.** This system is compatible with **Google Home and Alexa assistants.**



Awnings. Option to install a manual **pergola-style awning** (interior), mounted on the pre-prepared beam guides. Alternatively, a **veranda awning** (exterior) can be installed above the roof, motorized for ease of operation

where you want to be





fixed roof

Turn each space into an oasis of comfort and style. **The Atlas Series fixed roof** transforms the way you protect your home or business from the elements, allowing you to enjoy natural light and fresh air **without any hassle thanks to its advanced, durable and long-lasting design.**

We have available **two models of the same series**, one that contains **glass or sandwich panel**, with the possibility of

using both types in the same installation in different lanes, **and the other in its self-supporting form**, of which we would only speak of **sandwich panels without beams.**

catalog

where you want to be



discover our fixed roofs

The main advantage of the fixed roof is that it has been **designed to be compatible** with Acristalia's sliding roof. In addition to its own properties in **safety and comfort**, when configuring it, it is possible to request a roof with fixed and mobile lanes to alternate them (one fixed, one mobile, one fixed...), for example, or to put them continuously (two fixed and one mobile, one fixed and three mobile...), **making it possible to build unique spaces.**



With a minimalist design, the Atlas Series **fits perfectly with any room, providing spaciousness and luminosity.** Ideal for creating unique spaces.



You can enhance the space created by adding any of our series of glass walls and even awnings. **In addition, it is compatible with the sliding roof.**



A wide variety of accessories are available, such as lighting systems.



The evacuation of water in case of rain or cleaning is done **through the pillars.** The wiring is integrated into the structure itself, being **hidden and protected.**



Fixed roofs can be customized using the RAL color chart, which offers a wide range of **styles and finishes** to make each ceiling truly unique.



It arrives pre-assembled and machined, **the installation is very easy, fast and does not require any building work.** All the fixings are hidden to take care of the appearance.

where you want to be

general specifications

Energy Efficiency

Thanks to the high-quality glass used by Acristalia, **the Atlas Series retains heat in winter and keeps the interior cool in summer**, reducing the need for heating and air conditioning.

In the case of the self-supporting model, **its high-quality internal insulating material also helps regulate the temperature.**

Modern and Elegant Ambience

Its contemporary design adds a touch of modernity to spaces, which, when combined with other systems offered by Acristalia, **help renovate areas for both personal and business use.**



Which option is most suitable?

Our Atlas Series Fixed Roof is extremely versatile and adapts to all types of spaces. **You can choose between cascading roofs, gable roofs, or solutions for misalignments.** Additionally, **by combining it with our glass walls, whether with a self-supporting sandwich panel, you will have a comfortable and functional space to enjoy throughout the year.**

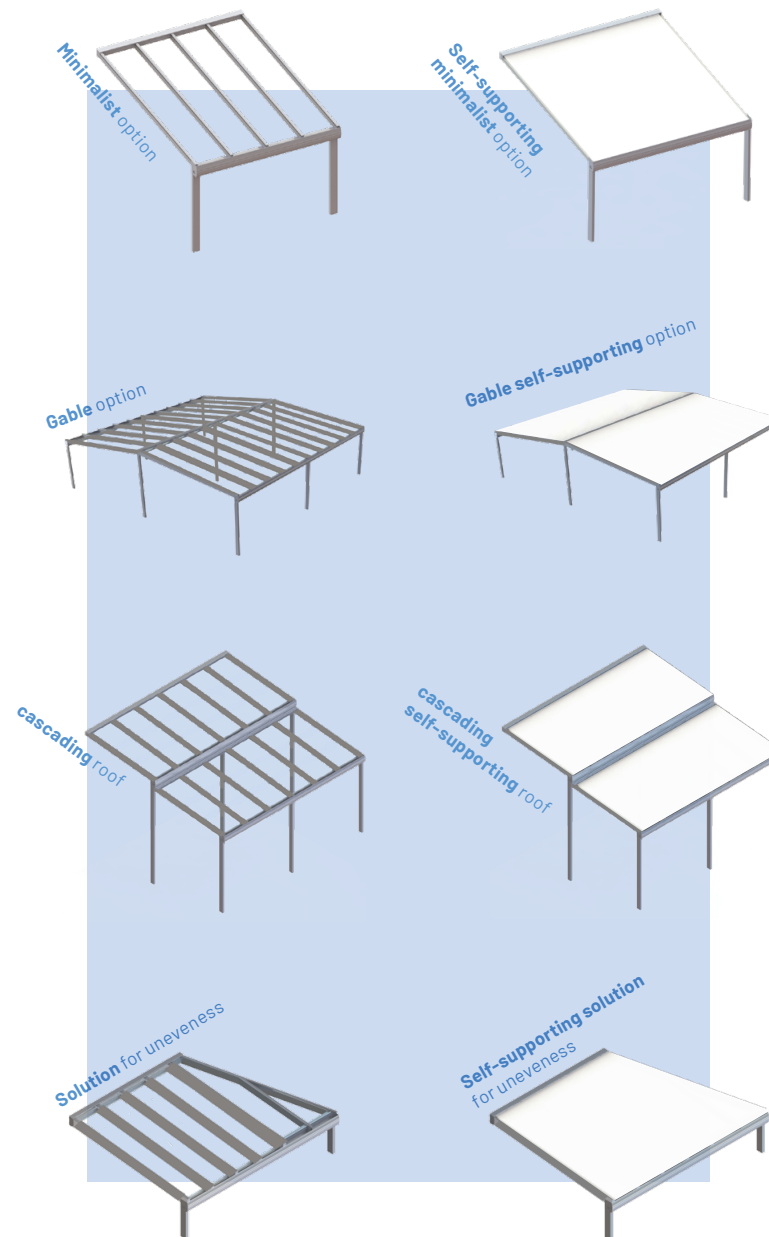

“

The multiple installation options and combinations with other systems allow **our fixed roofs to adapt perfectly** to each of our projects

_ Features of the Atlas Series...

Natural light flow

This system allows natural light to enter our room, which **improves illumination and reduces the use of artificial light during the day.**

Panoramic view

As it does not have horizontal profiles, **it provides a panoramic view of the sky and the exterior environment,** adding spaciousness and improving the quality and aesthetics of the space.

... and the Atlas self-supporting

Practical and elegant design

This system is a **practical and functional option, as well as decorative and aesthetic.** It allows the creation of large-sized recreational areas.

Minimalism

The absence of beams provides a clearer internal space, visually speaking. Thanks to its self-supporting panels, we can take advantage of larger surfaces.

where you want to be



The Atlas Series system is prepared to face the different environmental and meteorological situations that may occur. **Thanks to the sealing gaskets and glazing, we ensure the sealing between the lanes and the panels of the system,** the comfort of the users under the roof.

Thanks to the **tongue-and-groove joint system** of the Atlas self-supporting series, we manage to turn the roof into a large puzzle, avoiding the need for beams. **The self-supporting structure is conceived.**

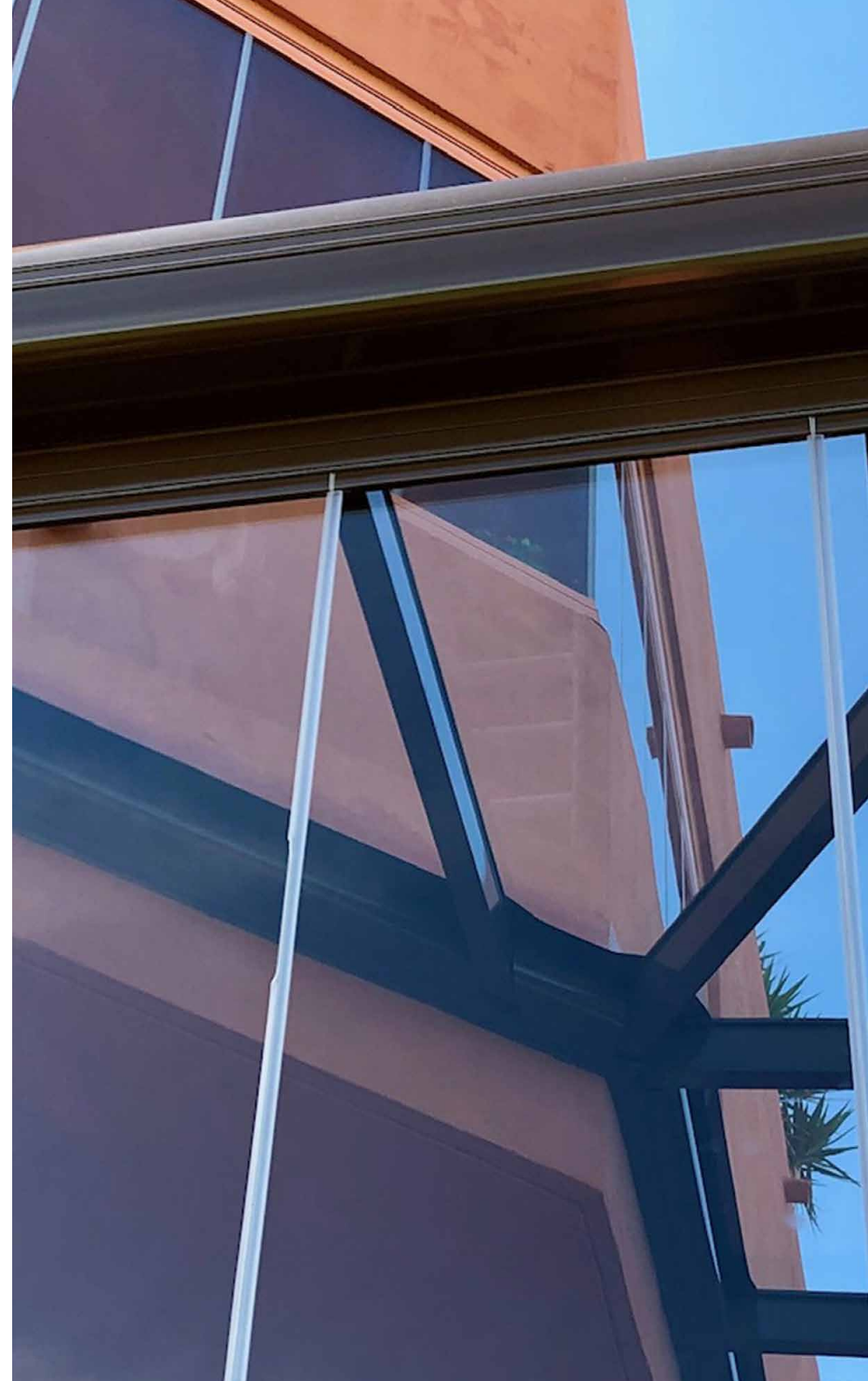

_ Add value to your project.

There are several add-ons that we can incorporate to our fixed ceilings. Below, we outline and explain **the main additions that favor the creation of a comfortable and cozy atmosphere.**



Lighting.

Acristalia has two lighting systems: LED spotlights that can be integrated into the beams for **fixed ceilings**, and LED strips (LED neon) **for fixed and self-supporting ceilings.**



Awnings.

Option to install a manual **pergola-style awning** (interior), mounted on the pre-prepared beam guides. **Not suitable for the fixed roof – Atlas Self-Supporting Series.**

“
At Acristalia
we are
manufacturers.
For this reason,
we carry out
**exhaustive quality
controls.**”

where you want to be



bioclimatic pergola

For your peace of mind, you should know that we are certified. Our products are subjected to strict controls, tests and trials. We work to make Acristalia synonymous with **safety and reliability**.

By choosing our products, you are not only acquiring an aesthetic element for your home or business, but also the confidence of having the highest quality and durability, protecting your investment in the long term.

But our **commitment** to quality goes beyond the products. We have a team of highly qualified **professionals** who **will assist you with any questions before, during and after the installation**.

In addition, we maintain a close relationship with our suppliers to **ensure that all materials used comply with our quality standards**.

Our certification guarantees that our manufacturing processes **satisfy the most stringent regulations**.

You can find all the documentation you need at www.acristalia.com/en

We do tell you, knowing is winning!



where you want to be

discover our bioclimatic pergola

catalog

These are, in summary, the most outstanding features of the system, with which **we were able to adapt perfectly in functionality and aesthetics** to the needs of our customers. In an exercise of design development, we managed to make this **compact and solid** structure, **light and integrated** in any environment without disturbing it in the least.



The functional system of **adjustable slats allow you to enjoy outdoor living all year** round by regulating the desired microclimate in a natural way.



There are **a variety of accessories and complements available** (lighting, heating, sound system and automatic sensors) which may be controlled through WiFi or Bluetooth.



The flow of water in case of rain or cleaning is expelled by means of beams and pillars. **The motor and wiring are fully integrated into the structure, remaining hidden and protected.**



You can enjoy even more your outdoor space by combining the bioclimatic pergola with our glazing systems **and awnings for perimetral closure.**



We supply a pre-assembled and machined system for **quick and easy installation without building work.** All fasteners are concealed to take care of the aesthetics.



The RAL colour chart allows you to customize the pergola. You can match colours by choosing one colour for the structure and slats caps and another colour for slats or design your entire pergola in the same colour.



_ What is offered by our pergola

Sun protection

Adjustable motorized slats **provide total protection against the solar radiation** at any time of day.

Ventilation

Allows the slats to rotate to create an air flow favored by the convection effect, from bottom to top, which regulates the temperature in a natural way.

Rain protection

When the slats are closed the rainwater is **channelled through the integrated drainage system in beams and pillars**.

Waterproof system

The slats contain a rubber seal that improves the waterproofing of the pergola, as the seal does not allow water to run into the joints between the slat.

At the same time, it reduces the noise that occurs between slats due to the vibration caused by the action of the wind.

Perimeter sealing

A registered system **that acts against sideways rain and that also does not allow direct light and/or reflected light to pass through the joints between the slats, or between the slats and the frame**.

This system helps to avoid a possible noise caused by the friction of the frame with the slats and the movement caused by the action of wind.

Slats filled with polyurethane foam

These help to eliminate the sound caused, for example, by rain, **acting as an acoustic insulator**.

The Acristalia Pergola: a versatile and comfortable shelter in any season.

The possible combinations are multiple, **adapting to different spaces**. Self-supporting, attached to a wall, duplex... the bioclimatic pergola can create cozy and functional spaces. In addition, thanks to **the combination with the glass walls** you can create environments to enjoy all year round.

self-supporting option

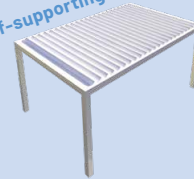

attached to the wall

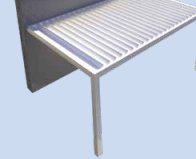

attached to a wall
(two sides)

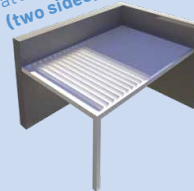

duplex

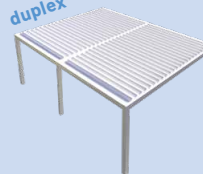

“

Adapt and connect
our pergola with
your space
and everything
will be in harmony!



The main feature of the Acristalia's Pergola is its system of **motorized adjustable slats, which are able to rotate from 0 to 135°**. This advantage is highlighted by the possibility of **memorizing positions** and control the degree of opening by remote control or mobile device.



“

Program the opening that you wish on your pergola from your cell phone or remote control with total precision.

technical characteristics

Invisible union of beams and pillars.

Made almost in one piece. **The intersections between beams and pillars of the bioclimatic pergola are almost invisible**, helping thus to maintain the visual cleanliness of profiles and creating a sense of the structural continuity.

Pillars height adjustment system

The pillars are equipped with a control system that adjusts the slight slope of the pergola to avoid **water and humidity stagnation on the top of the structure**.

Motor and wiring: hidden, protected and accessible

Our bioclimatic pergola has only automatic operating system with IP 65 protection. A motorization is discreetly hidden between slats and gutters, favouring aesthetics of the pergola

Integrated water drainage

The design of our pergola's louvers allows rainwater or condensation to be channelled away. **Water is directed into the side gutters, which require only a minimal slope to drain**, thus ensuring effective water evacuation.

Internal drainage option

The drainage system **enables rainwater collected in the gutters to flow into the pergola's support posts and be discharged at the desired location—either through a side outlet in the post or via a pre-installed floor drain.** The integrated pillar drainage accommodates a direct connection to a 75 mm-diameter PVC pipe, allowing water to be routed precisely where you need it.

_ Details that make the difference

There are **several add-ons that can be incorporated** to the structure of the bioclimatic pergola. The main ones are listed and explained below:



Sound insulation on slats thanks to the polyurethane foam with which are filled, achieving a significant reduction of **noise caused by rain** when falling on them, thus achieving a notable improvement in comfort.



Home automation. In addition to included remote control system, **the DAISY system can be incorporated, upon request, to be controlled by smartphones and tablets** via Wi-Fi connection. This system is compatible with **Google Home and Alexa assistants.**



Sensors. These safety elements serve to protect the structure and its fastening elements against strong winds and rain. They realize automatic control of adjustable slats to improve the comfort and to **optimize the energy efficiency.**

where you want to be





bioclimatic pergola
an oasis in your garden



Lighting. Built-in LED lights into the slats and LED RGB perimetral strips for ambient lighting: **a wide range of dimmable LED, monochromatic or coloured, designed to be integrated into the aluminium structure of the bioclimatic pergola.**



Audio system. Melody audio system **allows to play your favourite music from smartphones or tablets** via Bluetooth to create an ideal atmosphere.



Heater. Our pergola can be complemented by **electric radiant heaters of advanced infrared halogen quartz technology.** The heater can be controlled and regulated by a receiver integrated into home automation system.



Plug. Optional **230 V power outlet with protective cap and with IP45 protection built into the pillar** will allow you to power any device.

where you want to be

have you not
our products
what would be
combination
for v

noticed that all
fit together?
Are the perfect
combination of systems
you?

where you want to be



vertical sliding wall



panoramic **guillotine**
a multifunctional system

The Brisa Series vertical sliding wall is a multifunctional panoramic system that amplifies the advantages of both windows and walk-through areas, as it combines these two concepts in a **single exceptional product**.

Glass for large openings, with “guillotine” type vertical sliding movement, with both top and bottom storage, providing unlimited views for the consumer.

And **maximising the use of openings** in buildings for architecture and decoration professionals.

And all **without requiring any additional space** and with a number of extras that increase the possibilities of its use.



discover our the Brisa series

Throughout these years, Acristalia has been **distinguished** for constantly improving **the range and variety of glass enclosures** on the market, providing **the best service** for all its products.

The vertical sliding glass wall system Brisa Series increases the range of versatile products to suit our customers, providing them with solutions they could not not even imagined.

where you want to be



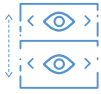

Vertical sliding glass panels, provide continuous and transparent transparent surfaces for an **unparalleled panoramic view**.



The system has a **wide variety** of possibilities in terms of **finishes colour combinations of the profiles**, adapting to any preference or corporate image.



Time saving and implementation increased, thanks to our **vitriified digital printing**, with the facility to receive **preprinted glass sheets directly from the factory**.



Perfect **solution** for integration into **exterior façades**, being suitable for for hospitality projects that require **refurbishment or new construction**.



“

The panels can perform their complete movement or they can be stopped at any point on demand with the remote control.

+

Opening mode.

Due to its opening position, the system is able **to provide a larger useful space**, making it the perfect ally to make profitable every square meter of your commercial premises.

_ How the vertical sliding wall works

As we have already mentioned, the operation of the of **the Brisa Series** is quite simple: **upper or lower storage**, depending on the use you want to make of it.

From the imagination to the practical idea of **your façade design** by simply **combining the two storage solutions**, achieving, in a surprising way and **with only one system**, different passageways but visually coherent.

Upper storage

This concept, that could be referred to as a “door” type system, **facilitates the passage** in divided spaces still in need of **connection**:

- _ Creation of doors or access points
- _ Use of 2 or 3 panels
- _ Maximum size: 3500 x 3500 mm
- _ When fully open, the panels are fitted behind the top fixed panel.

Lower storage

This option could be referred to as a “window” type, although it is also **integrated** as a glass wall because of the final result of the panels storage.

- _ Balustrade option
- _ Use of 2 or 3 panels
- _ Maximum size: 3500 x 3500 mm
- _ When fully open, the panels are fitted behind the bottom fixed panel.



Panels with **upper storage** make this glazed enclosure versatile **as a door, but with the advantage of not reducing any valuable space.**

The panels with **lower storage** allow the glazed enclosure to be used both to **divide spaces and to improve ventilation** without reducing useful and accessible spaces. This option is visually displayed as a railing, allowing the area to be delimited.

highlights of the system... **discover its features!**

Both the drive system and the motorization **are concealed**. In addition, **the tubular motor is direct drive**.

Max. weight of the retractable section: 190 Kg. Very neat aesthetic appearance **thanks to its minimalist frames and profiles**.

The guides and rails are hidden thanks to their specific trims. **Installation and handling are simple**, advantages that are appreciated by both the professional installer and the end user.

By the operation of the system itself, **we ensure that no extra or special maintenance is required**. Control over air circulation quite unique and advantageous.

Operation by remote control or push button.

Extras such as **wind reinforcement, smartphone control, locking latch** (for upper storage) or photocell security (for lower storage) on request.

panoramie guillette
a multifunctional system

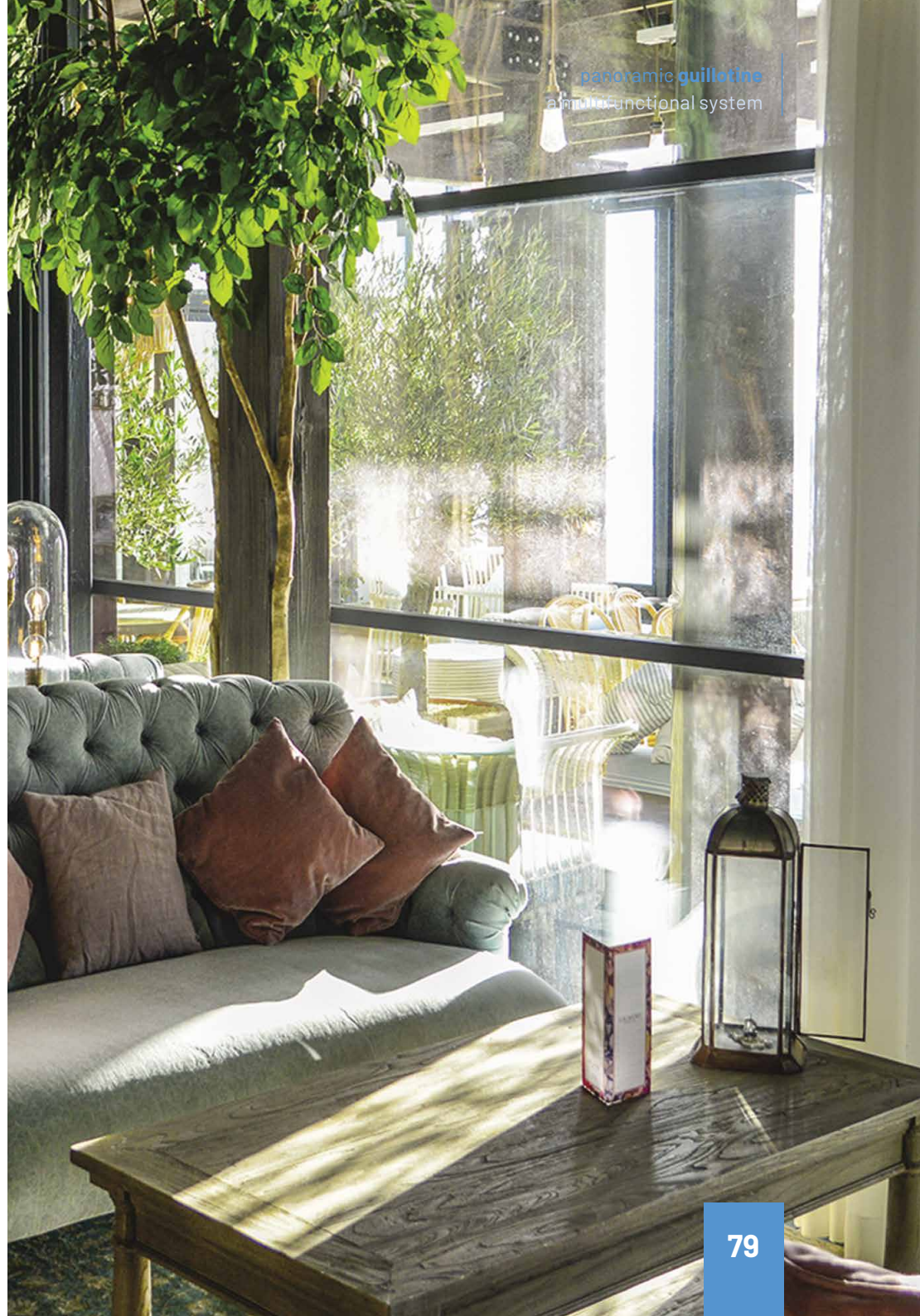



“

This system brings an immense range of possibilities: improving the performance of windows and guardhouses, in customer services or in the hospitality sector, as well as in any home.



Locking latch

For upper storage. This system allows to fix the movable panel to the side frame to prevent the sash from opening from below.



Photocell safety

For upper storage. Thanks to its technology, it allows the door to stop when lowered **if it detects a person, animal or object passing at that moment.**



Smartphone control

Easy and simple. You can control the opening or closing of the system with just one click.



Concealed guides with anti-particles brush

A refined aesthetic. The tracks are concealed and protected by the profile geometry.

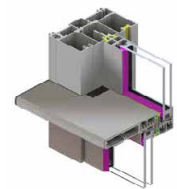

Wind reinforcement / balustrade

Possibility to choose the option with reinforcement for areas with strong winds.

_ Extras and accessories

The **Brisa series** vertical sliding panels system, in addition to being an **easy to install and quick to assemble** structure, adds some **extras that make it unbeatable** in its class, making it even **more attractive** to be chosen among your **glazed enclosure options**.

where you want to be



adjustable windbreaker

Our **retractable windbreaker Ascendo series stands out for its simplicity**, which, although it may seem contradictory, turns out to be precisely its greatest quality. **No metal profiles in the extendable glass**, panoramic vision and protection are assured.

The **movable drive elements** of the extendable panel **are invisible**, as we have expressly designed it to be **concealed in the structure**, therefore confirming the premise of complying with a minimalist, user-friendly and practical design. Another feature of our retractable windbreaker is the possibility of **holding the sliding glass at the desired** height between the “open” and “closed” positions.

The Ascendo series is delivered **ready for installation**, although different configurations are available in terms of size and installation, highlighting its flexibility in adapting to different spaces. **A unique extendable windbreaker system on the market.**



where you want to be



discover our windbreaker

The technical characteristics of this system make its functionality and design truly stand out. Combined with its ability to adapt to final use requirements, they give this product unique qualities that set it apart from other comparable solutions.



The system offers a **wide variety of possibilities** of finishes and colour combinations in the profiles, adapting to any style.



This capacity for adaptation and implementation is enhanced with the possibility of **printing the glass in the factory, thanks to our digital vitrified printing system.**



Perfect solution for integration in both **facades and interiors**, being suitable for **refurbishment projects and new construction projects.**



Extendable sliding glass panels without vertical profiles **provide continuous, transparent surfaces** with all the operating components concealed.



adjustable **windbreaker**
space demarcation.

_ Adjustable system to the required height



The Ascendo series could not be simpler: **no motors, no controls, no effort**, but with full reliability.

Lifting the movable glass / extending the windbreaker

Place both hands on the upper edge of the movable glass (inner sheet of glass) and pull it upwards. **The glass can be raised to its maximum height or leave it at any point along its travel, while maintaining the glass in its position.**

Lowering the movable glass / closing the windbreaker

Place your hands back on the extended glass edge and apply downward at any point on the glass. **The movable glass may be left at any point along its path, while maintaining its position.**

The lifting system allows the glass **to be held at any desired height throughout its entire range**, from the minimum to the maximum height.

*Heights	
FOLDED HEIGHT	EXTENDED HEIGHT
1000	1700
1100	1800
1200	1900

* Measurements in mm

Width is variable:

- MINIMUM WIDTH 1000 mm
- MAXIMUM WIDTH 2000 mm

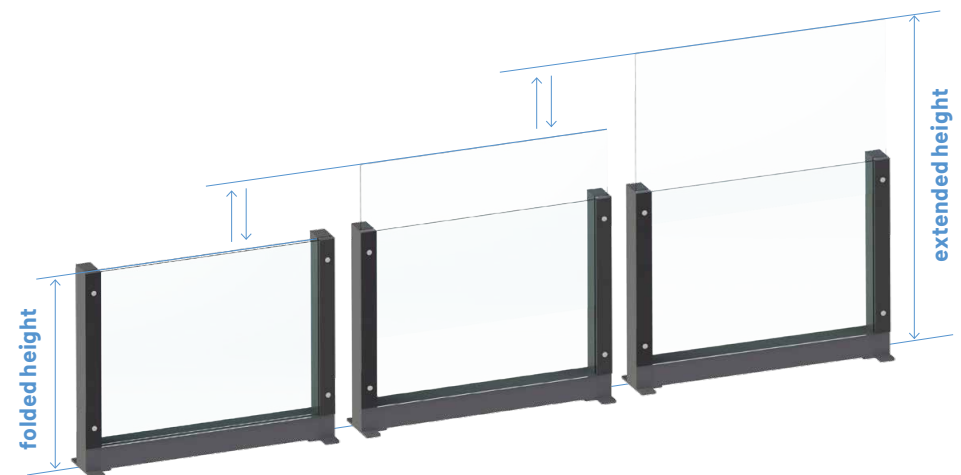

where you want to be

discover the installation options

with base fixed to
the to the ground

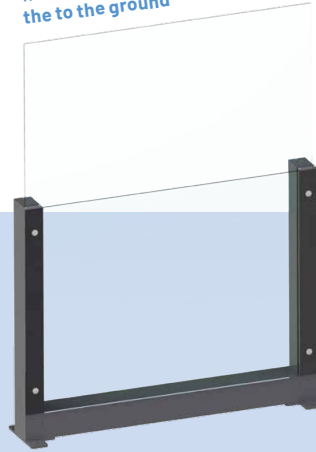

option
on wheels



with base fixed
to the ground and planter

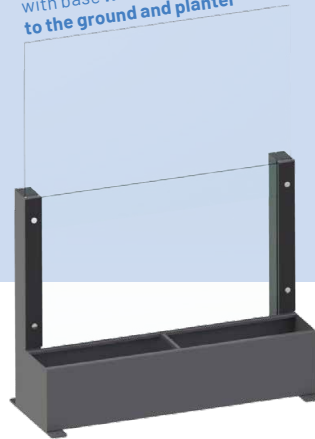

option on wheels
with planter

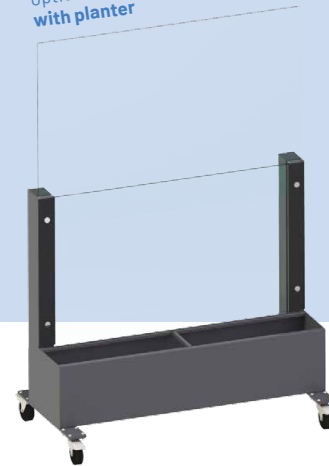

The Ascendo series redefines simplicity. Without the need for complex motors or controls, its operation is intuitive and effortless. Enjoy all the reliability you need, without the hassle. **It also represents a significant leap forward in innovation, delivering smooth and dependable performance.** Experience technology at the service of your comfort.

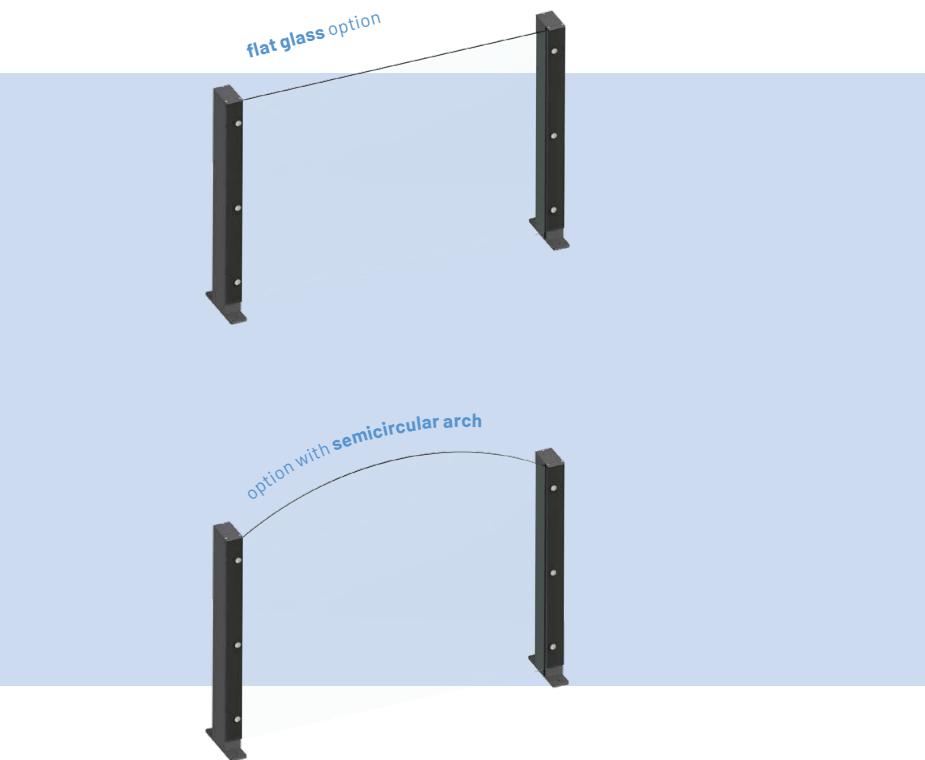

“
In case of
opting for the
windbreaker
on wheels, it is
important to know
that they rotate
360°. In addition,
they incorporate a
locking pedal to
position and stop
the system.

do you need
a fixed wind-
shield?... with
the fixed
windbreak **you**
can define
spaces with-
out giving up
the sensation
of spacious-
ness.

Once introduced the specifications of the Ascendo extendable windbreaker, we present **the version without the rising panel, the Fixendo series**, with its two available options (straight glass or semicircular glass) We will also explain their possible configurations (same as the mobile option) which we adapt to the required needs.

where you want to be

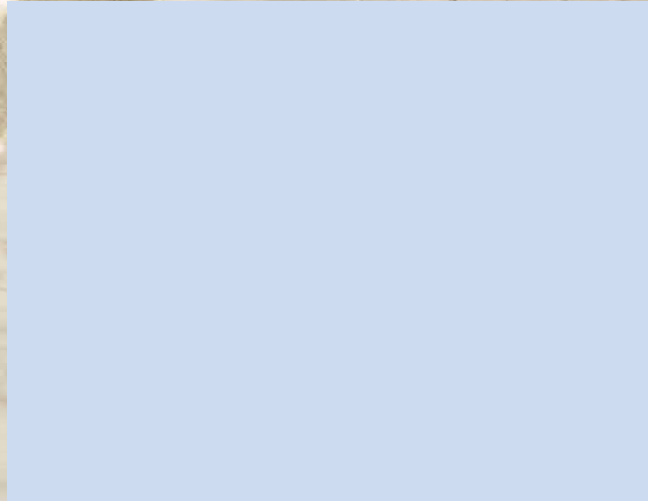



glass railings

Picture a product where elegance merges with functionality, where security meets transparent. This system, resulting from the most conscientious engineering and design, is not only an aesthetic element, but also a long-term investment that adds value to any property, **offering an elegant and practical solution** offering an elegant and practical solution.

Our Railing series glass balustrade is much more than a simple safety element. It is an opening to the world that **allows natural light to flood the spaces and create bright and welcoming environments.** Moreover, its installation possibilities on any surface increase its advantages by three times.



get to know our railing

The Railing series are one more step in delimiting spaces. The design developed by Acristalia **allows the use of a type of railing that takes care of aesthetics, is safe and makes it possible to continue with views of the landscape** from any position.

With this dossier, you will be able to know the different aspects that concern this product and that will help you understand it better for its subsequent installation.

Along with the results of the tests with which the Railing Series has been tested, you will see **a guide to installation possibilities**. Also, some samples of the careful design and functionality of the product, the technical characteristics, measurements, types of glass and aluminum profiles, as well as a list of accessories that enhance, if required, the installation possibilities of this glass railing.



Functional system with **installation options with a single profile**, establishing the trend in the industry.



System with **a wide variety** possibilities available in terms of **finishes and color combinations in the profiles**, adapting to any taste or corporate images.



Savings in time and implementation, thanks to our **vitrified digital printing system**, granting the advantage of receiving the glass already **printed directly from its manufacture**.



Glasses that provide continuous and transparent views achieving **a total panoramic vision**.



Full compatibility with or **Basic Pro Series** wall system. Thanks to the design of the **handrail**, the handrail acts as **a safety lane support** for the glass wall



Perfect solution to integrate into exterior facades, being suitable for hospitality projects that require new construction or are **new construction**.

“
Transform your
business and home
with this system:
experience a
before and an after,
maximize
your space.”

_ One profile three solutions

One of the reasons why it is worthwhile worthwhile to install the Railing Series, is its **adaptability**. With the same profile, it allows three different different types of installation: **surfaced, embedded and side-mounted**.

Designed with this functionality, it gains **aesthetic coherence** and visual uniformity, in addition to a **very simple installation system unified** in a single product.

Surfaced option

In the surfaced solution, the profile is screwed on top of the floor, providing extra protection protection to the glass in the form of a plinth.

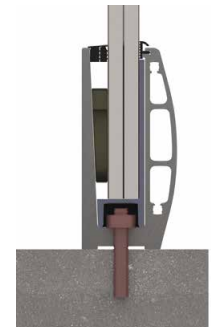

Embedded option

The solution em-
bedded inserts the
profile on site by
screwing it from the
base, leaving only
the glass and the
upper sealing upper
rubber at sight.

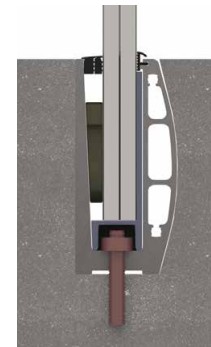

Side-mounted option

For the side-mount-
ed solution side
option, the profile is
screwed to the wall
from the outside
with the addition of
an embellishing cover
profile attached.

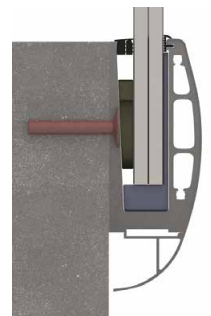

different installation solutions. which one suits best?

where you want to be

The possible options are multiple, since **the Railing Series adapts perfectly to the different spaces needed.** When we think about railings, the straight version is the first that comes to mind, but with a little imagination and our Railing Series, we can create novel and functional spaces without compromising visibility and gaining comfort.

Whether it is a corner, a terrace or a passageway (such as a staircase or a hallway), the railings of our Railing Series are the right choice: **fully adaptable to the space and combinable with the Basic Pro Series glass curtains,** configuring to your liking. tasteful environments in which to enjoy throughout the year.

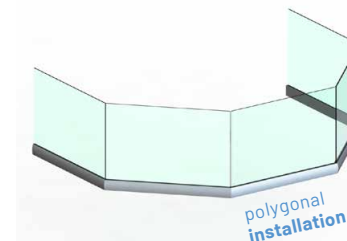
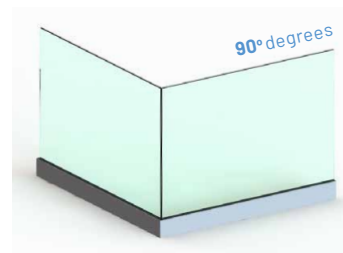
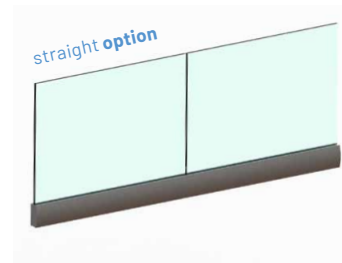

“

Design your space, create unique environments, personalize and transform any corner, terrace, staircase... The Railing series can do it!



discover other options

_ Clamps: Romo and Vorte Series

Our Romo and Vorte series are clamps for floor fixing to the floor, for glass railings made of aluminum. They are a remarkable option for modern and elegant architectural projects.

They are designed with meticulous precision to provide **secure and reliable clamping** of the glass, which ensures the stability and safety of the railing as well as its **quality and functionality**.

On top of their performance, our series of floor clamp series also stand out for their **contemporary design**. Their clean, sophisticated finish adds a touch of **modern style** to any space, whether in **residential, commercial or public** environments, perfectly complementing a wide range of architectural designs.



Lightness and stability. The use of aluminum gives the clamps a lightweight construction, which facilitates handling and installation without compromising the strength and stability and stability of the glass railing.

_ Buttons connectors: Conect Series

We present our **buttons connectors and aligners for glass railings**, essential to ensure **safety and style** in a variety of architectural applications, such as stair railings inside the home.

Our **Conect series for glass balustrades** are designed with a focus on quality and functionality. These pieces, which resemble elegant buttons, are made of high quality materials to ensure a **secure attachment of the glass** to the wall or other structural elements.



Minimum visual impact. No need to of installing poles, the connectors are a superior aesthetic option, without compromising the strength and stability of the glass railings, which they secure.

As a result, in addition to their superior performance, our glass railing connectors also offer a sleek and elegant and discreet design. Their minimalist appearance complements a wide range of architectural styles, adding a touch of sophistication to any residential space.



doors and
bioclimat-
ic pergola;
railings with
slide & fold
glazing, fixed
roof and
sliding glass
roof...

Next...
successful
combina-
tions: sliding &
fold glazing
with sliding
glass roof;
panoramic
sliding glass

where you want to be

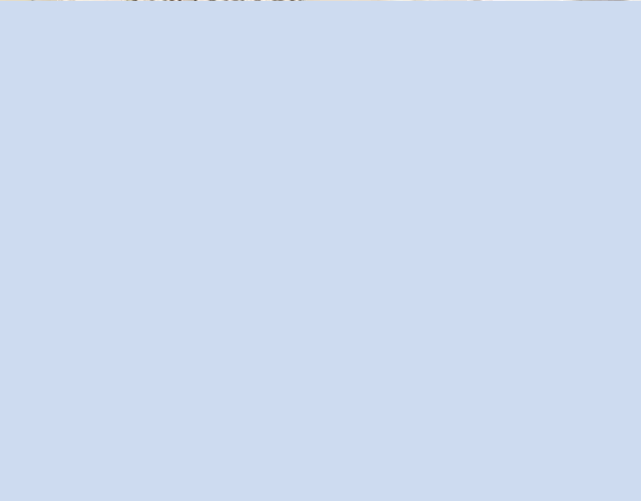

combine our series



Have you ever considered the potential of **combining a sliding folding system with a glass roof?** Or how you could make the most of a bioclimatic pergola, located in a garden as a porch, if you were to integrate it with a transparent entrance? We can tell you all about it. Below, we describe the features of our series that can be combined. **And this is just a small sample of how far they can go. Contact us to expand your opportunities.**

fixed roof + slide & fold glazing + railing

In response to the imperative of creating **safe spaces**, we developed the harmonization of the **Railing and Basic Pro series, integrating both products in the same installation** for this this purpose.

The railing can be used as a **handrail** for a simple balustrade installation or as a bottom profile **guide for the Basic Pro Series slide & fold glazing system**. We offer a fully integrated solution as we have a wide range of brackets, catalog of brackets, components, glass alignment and accessories, **that will turn your vision into a reality**. On top of that, all profiles are customizable.



Basic Pro Series

Up to **2 meters in height**

70 cm maximum panel width

Minimalist profiles

Glass thicknesses of **6, 8 and 10 mm**

Railing Series

Different glass thicknesses:
from **6+6 up to 12+12**

Compatible with **laminated or laminated + tempered glass**

Mounting options: **recessed, surfaced and side mounting**





sliding glass doors + sliding roof

possible **combinations**
renovate your space

In addition to the roof of the Sliding Series, **the panoramic sliding Tandem Series, offers a glazed enclosure formula that combines design and comfort as an integral solution.** In this case, it offers a new space for personal enjoyment or to make it profitable all year round if installed on a hospitality terrace. This combination is a winning combination of safety, aesthetics and functionality.



Tandem Series

Up to **3,5 meters in height**

7 mm height adjustment on bearings

Optimized rails to facilitate **water evacuation or continuous for opening from both sides**

10 y 12 mm glass thickness

Sliding Series

Multiple **configurations**

Allows an **inclination of up to 22 degrees**

Possible installation of **LED lights or rain and wind sensors**

The maximum panel thickness is 20 mm

Committed to the importance of providing **comfortable spaces**, we deliver unique solutions that are out of the ordinary. We rely on the practical fusion of **two (or more) of our series in the same installation** to achieve maximum return on investment and **create new possibilities of habitability and use.**

The wide range of options inherent in the design of our bioclimatic pergola perfectly aligns with the flexibility of the Standard Series glazing slide and fold system, fully meeting this vision.



Standard Series

Up to **2 meters in height**

70 cm maximum panel width

Minimalist profiles

6, 8 y 10 mm glass thicknesses

Pergola Series

Allows dimensions of up to **4,2 x 6,2 meters**

Multiple configurations

Motorized adjustable slats capable to rotate **from 0 to 135 degrees**

Incorporation of **home domotics, sensors, led lighting and audio system with bluetooth**

frameless slide & fold + pergola





keep on combining
options until you
find your match...
**create your own
design!**





acristalia

www.acristalia.com | [in](#) [f](#) [@](#) [p](#) [v](#) [▶](#)